

DO NOT SCALE FROM THIS PRINT

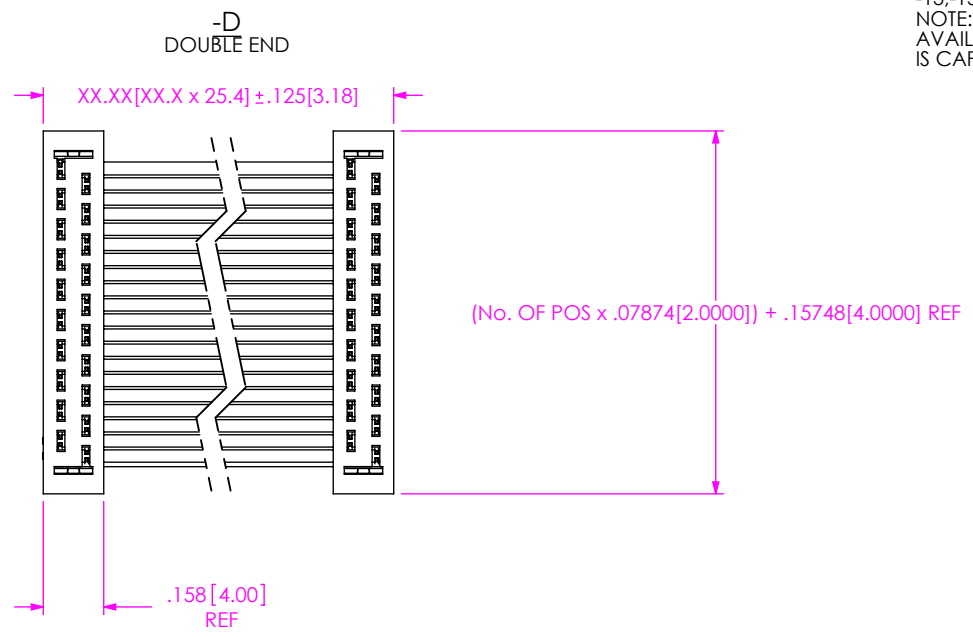

No OF POSITIONS
 -03,-04,-05,-08,-10,-12,-13,-15,-17,-20,-22,-25
 NOTE: OTHER POSITIONS AVAILALE AS ASO. TOOL IS CAPABLE OF POSITIONS 2-25

OPTION
 SEE OPTIONS BELOW

OPTION
 SEE OPTIONS BELOW

OPTION
 LEAVE BLANK FOR STANDARD
 -F: FLASH GOLD PLATING
 TRANSFER END ONLY
 (USE TCSD-XX-01-F)

LEAD STYLE

END ASSEMBLY
 -D: DOUBLE END
 -S: SINGLE END
 -T: TRANSFER END

ASSEMBLY LENGTH
 (2 INCH MINIMUM)

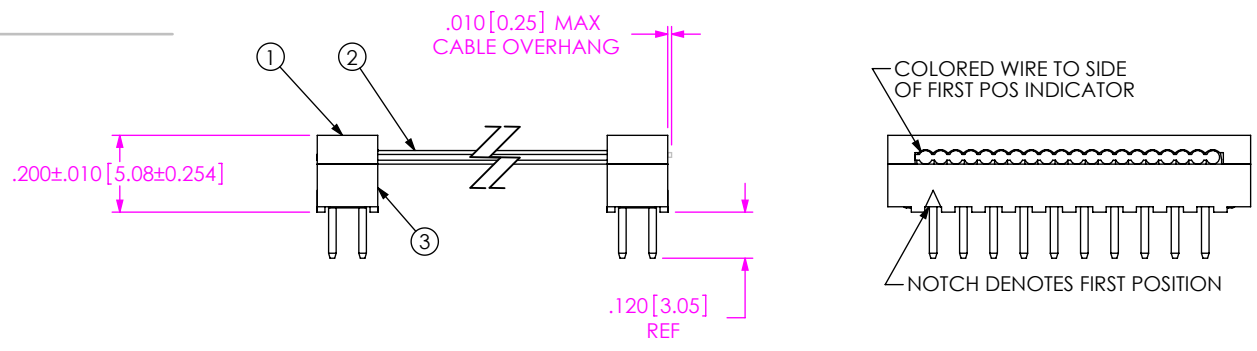
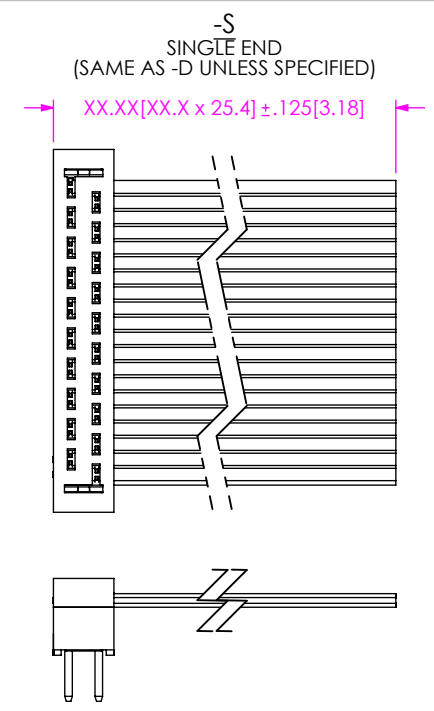



TABLE 1	
ITEM #	PART
1	TCSD-XX-01-XXX
2	TCB-50
3	TCMD-XX-01
4	TCMD-XX-01-SR
5	TMSR-XX
6	TTC-XX-D
7	T-1S14-XX-X

- NOTES:
- ① REPRESENTS A CRITICAL DIMENSION.
 - AS OF REV C ON TCB-50 CABLE, ASSEMBLIES WILL BE LEAD FREE.
 - ALL ASSEMBLIES TO BE 100 % ELECTRONICALLY TESTED FOR SHORTS AND OPENS.
 - ALL ASSEMBLIES TO BE 100 % HI-POT TESTED AT 800V.
 - STRAIN RELIEF TO WITHSTAND 5LBS STRAIGHT PULL.

UNLESS OTHERWISE SPECIFIED, DIMENSIONS ARE IN INCHES. TOLERANCES ARE: DECIMALS ANGLES .XX: ±.01 [.3] 2° .XXX: ±.005 [.13] .XXXX: ±.0020 [.051]	PROPRIETARY NOTE THIS DOCUMENT CONTAINS INFORMATION CONFIDENTIAL AND PROPRIETARY TO SAMTEC, INC. AND SHALL NOT BE REPRODUCED OR TRANSFERRED TO OTHER DOCUMENTS OR DISCLOSED TO OTHERS OR USED FOR ANY PURPOSE OTHER THAN THAT WHICH IT WAS OBTAINED WITHOUT THE EXPRESSED WRITTEN CONSENT OF SAMTEC, INC.	 520 PARK EAST BLVD, NEW ALBANY, IN 47150 PHONE: 812-944-6733 FAX: 812-948-5047 e-Mail: info@SAMTEC.com code: 55322

S

-SR:
STRAIN RELIEF
(NOT AVAILABLE WITH -O, -M, -R, -DXX, OR -BXX)
(SOLD AS ASSEMBLIES ONLY)
(SAME AS -D UNLESS SPECIFIED)

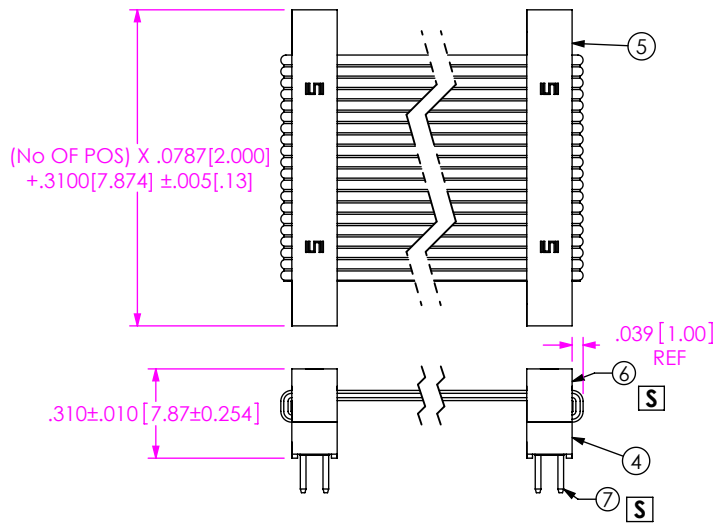

IN-PROCESS 1

-SR ONLY

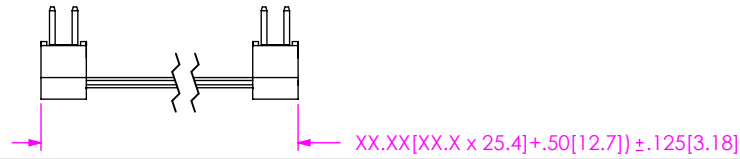

IN-PROCESS 2

-SR ONLY

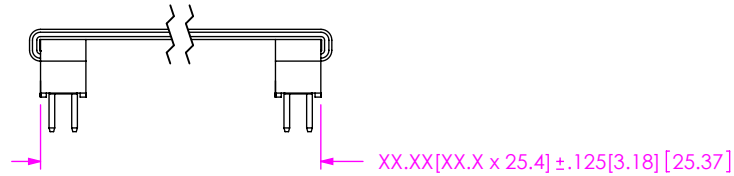

-N
NOTCH POLARIZATION
(FOR -T ONLY)
(IF OPTION IS SPECIFIED
USE TCSD-XX-01-N)

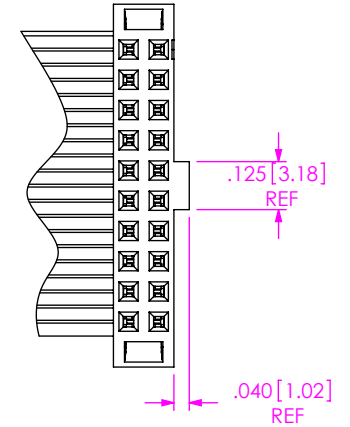

-RW
REVERSE WIRING

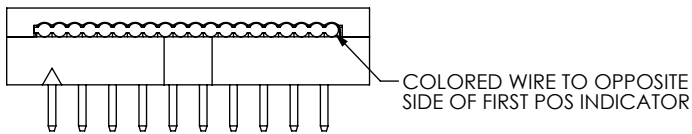

-P"XX"
POLARIZED MATING
(USE PK-07-N POLARIZING KEY)
(THE SAME POSITION WILL
BE POLARIZED ON BOTH ENDS)

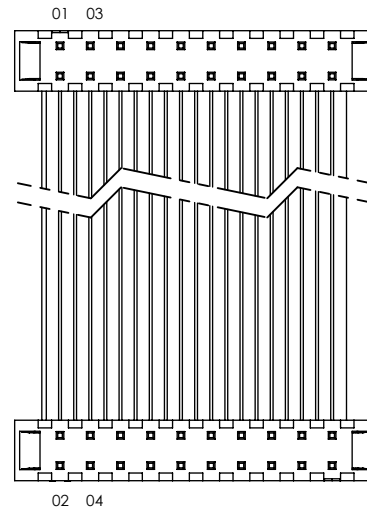

-BXX
BREAKOUT OPTION
"XX" = NO OF CONDUCTORS PER ROW
BROKEN OUT FROM THE FIRST POSITION

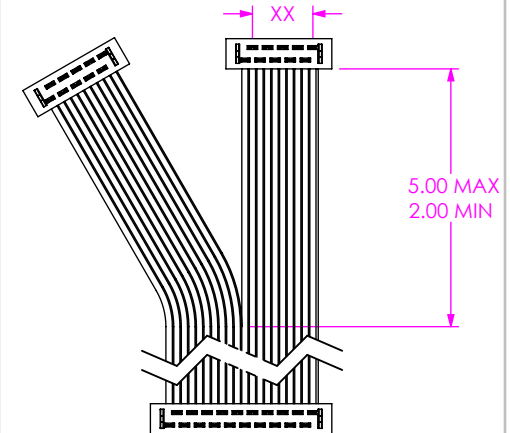

-T
TRANSFER END
(SAME AS -D UNLESS SPECIFIED)

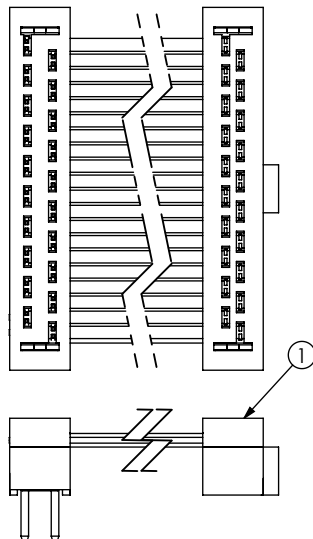

PROPRIETARY NOTE

THIS DOCUMENT CONTAINS INFORMATION
CONFIDENTIAL AND PROPRIETARY TO
SAMTEC, INC. AND SHALL NOT BE REPRODUCED
OR TRANSFERRED TO OTHER DOCUMENTS OR
DISCLOSED TO OTHERS OR USED FOR ANY
PURPOSE OTHER THAN THAT WHICH IT WAS
OBTAINED WITHOUT THE EXPRESSED WRITTEN
CONSENT OF SAMTEC, INC.

DO NOT SCALE DRAWING

SHEET SCALE: 1:5:1

samtec

520 PARK EAST BLVD, NEW ALBANY, IN 47150
PHONE: 812-944-6733 FAX: 812-948-5047
e-Mail: info@SAMTEC.com code: 55322

DESCRIPTION:
2MM DOUBLE ROW MALE IDC CABLE ASSEMBLY

DWG. NO.
TCMD-XX-X-XX.XX-01-X-XXX-XXX

BY: B RAY 11/26/2007 SHEET 2 OF 4

-O
OUTSIDE REVERSED

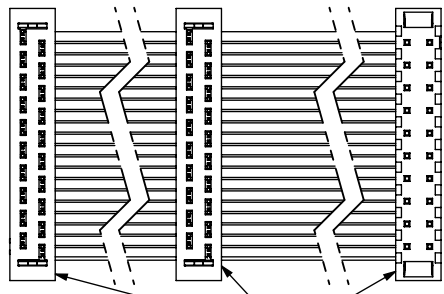

FIRST POSITION INDICATOR

$XX.XX[XX.X \times 25.4] \pm .125[3.18]$

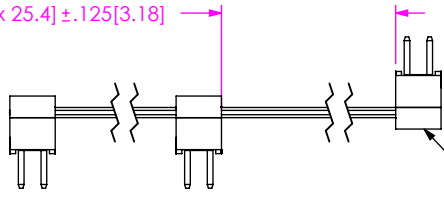

OUTSIDE SOCKET REVERSED
WHEN DAISY CHAINED

-M
MIDDLE REVERSED

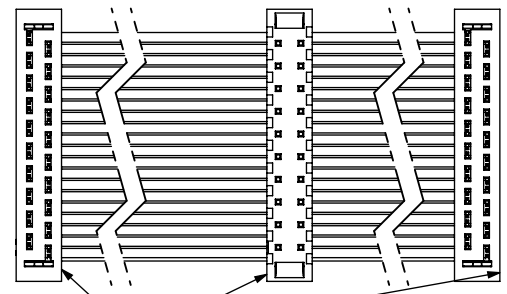

FIRST POSITION INDICATOR

$XX.XX[XX.X \times 25.4] \pm .125[3.18]$

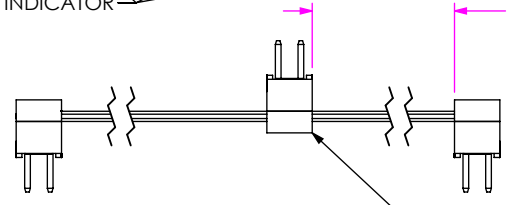

MIDDLE TERMINAL REVERSED
WHEN DAISY CHAINED

-O
OUTSIDE TRANSFER

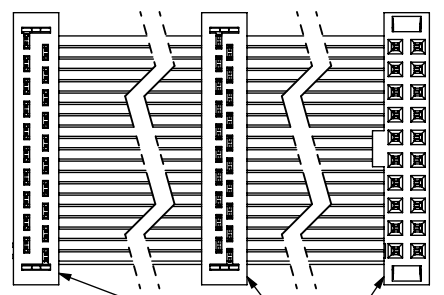

FIRST POSITION INDICATOR

$XX.XX[XX.X \times 25.4] \pm .125[3.18]$

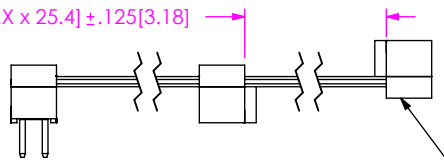

OUTSIDE SOCKET REVERSED
WHEN DAISY CHAINED

-M
MIDDLE TRANSFER

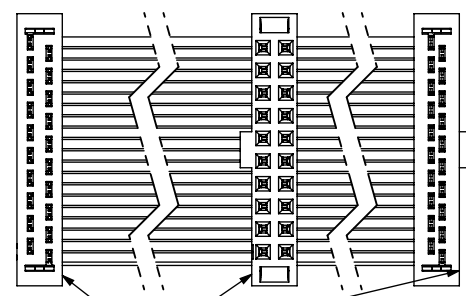

FIRST POSITION INDICATOR

$XX.XX[XX.X \times 25.4] \pm .125[3.18]$

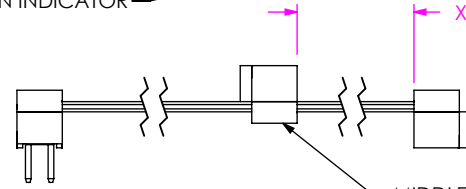

MIDDLE TERMINAL REVERSED
WHEN DAISY CHAINED

PROPRIETARY NOTE

THIS DOCUMENT CONTAINS INFORMATION CONFIDENTIAL AND PROPRIETARY TO SAMTEC, INC. AND SHALL NOT BE REPRODUCED OR TRANSFERRED TO OTHER DOCUMENTS OR DISCLOSED TO OTHERS OR USED FOR ANY PURPOSE OTHER THAN THAT WHICH IT WAS OBTAINED WITHOUT THE EXPRESSED WRITTEN CONSENT OF SAMTEC, INC.

DO NOT SCALE DRAWING

SHEET SCALE: 1.5:1



520 PARK EAST BLVD, NEW ALBANY, IN 47150
PHONE: 812-944-6733 FAX: 812-948-5047
e-Mail: info@SAMTEC.com code: 55322

DESCRIPTION:
2MM DOUBLE ROW MALE IDC CABLE ASSEMBLY

DWG. NO.
TCMD-XX-X-XX.XX-01-X-XXX-XXX

BY: B RAY 11/26/2007 SHEET 3 OF 4

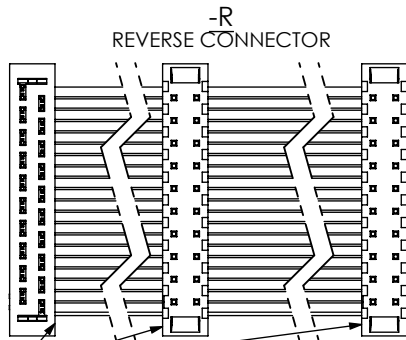

FIRST POSITION INDICATOR

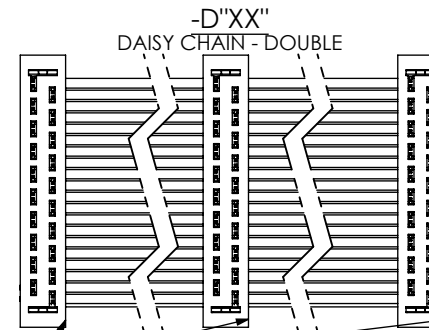
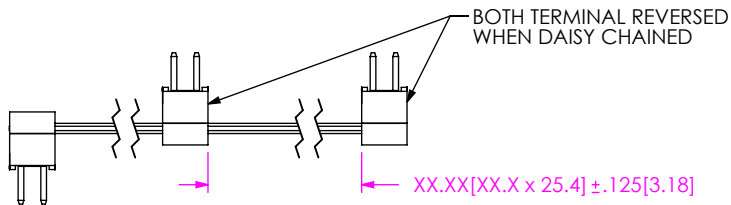

FIRST POSITION INDICATOR

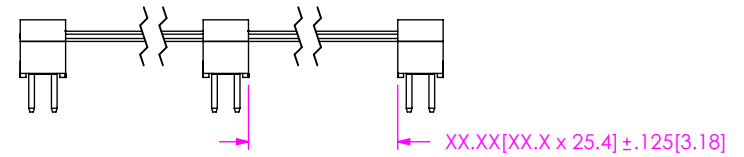

NOTE:
2" MINIMUM LENGTH
1" INCREMENTS ONLY

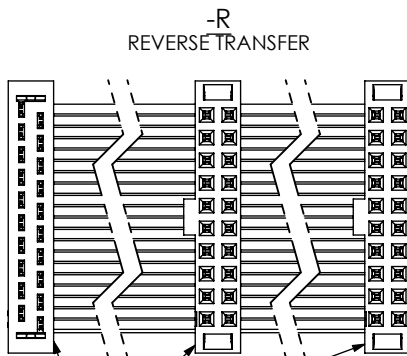

FIRST POSITION INDICATOR

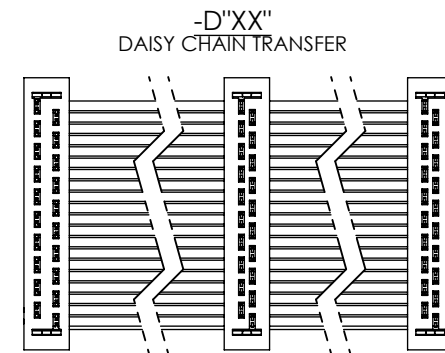
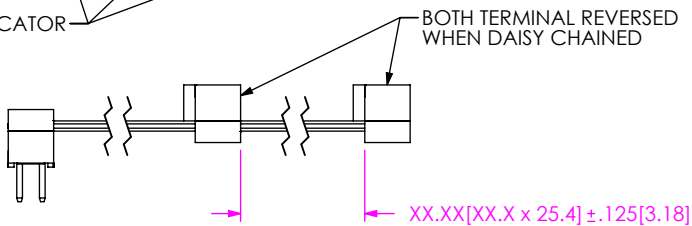

NOTE:
2" MINIMUM LENGTH
1" INCREMENTS ONLY

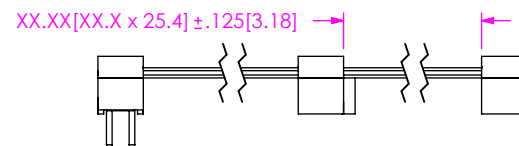

PROPRIETARY NOTE

THIS DOCUMENT CONTAINS INFORMATION CONFIDENTIAL AND PROPRIETARY TO SAMTEC, INC. AND SHALL NOT BE REPRODUCED OR TRANSFERRED TO OTHER DOCUMENTS OR DISCLOSED TO OTHERS OR USED FOR ANY PURPOSE OTHER THAN THAT WHICH IT WAS OBTAINED WITHOUT THE EXPRESSED WRITTEN CONSENT OF SAMTEC, INC.

DO NOT SCALE DRAWING

SHEET SCALE: 1.5:1



520 PARK EAST BLVD, NEW ALBANY, IN 47150
PHONE: 812-944-6733 FAX: 812-948-5047
e-Mail: info@SAMTEC.com code: 55322

DESCRIPTION:
2MM DOUBLE ROW MALE IDC CABLE ASSEMBLY

DWG. NO.
TCMD-XX-X-XX.XX-01-X-XXX-XXX

BY: B RAY 11/26/2007 SHEET 4 OF 4